

Safety Products & Construction Materials



IPSS CATALOGUE

'07

Introduction

International Project Support Services - IPSS Ltd. with its main office in Tbilisi and branches in United States and Ireland was founded in 2001 with the mission of providing logistics and consultancy service to foreign companies, International missions, and NGOs.

IPSS has recently expanded its services to include:

- Construction Material Supply
- PPE Supply
- Product sourcing specific to client's needs
- Importation service
- Accommodation and Life Support
- Supply of work space, facilities and services

IPSS has the resources and the experienced team, ready to deal with our clients' Procurement and Logistics needs. We offer a value added service to allow our clients to forget their supply woes and focus on their core business.

IPSS is a distributor of personal protective equipment and many other occupational safety supplies, quality brands from the top manufacturers in United States and Europe.

Quality and competence are the basis of our work. Our commitment to providing safety products of the highest quality, for the benefit of the consumer, has been our top priority. Our technical expertise ensures that the customer gets the right product for the job first time round. Our goal of progress and foresight, reaffirm the company's continuing aspiration to supplying our valued customers with new innovative products that satisfies their demands.

Whether you are an individual expatriate or a global multinational company, we assure your success with our wide range of Safety Products.



Contents

<i>First Aid Kits</i>	3
<i>Protective Clothing</i>	5
<i>High Visibility Clothing</i>	9
<i>Head Protection</i>	11
<i>Eye and Face Protection</i>	12
<i>Foot Protection</i>	17
<i>Fall Protection</i>	20
<i>Safety Signs / Tapes</i>	22
<i>Hearing Protection</i>	23
<i>Hand Protection</i>	26
<i>Winter Gear</i>	29
<i>Fire Protection</i>	32
<i>Hitech</i>	35

IPSS is the first official distributor of



Dyna Med® Trunk First Aid Kit



FA00001



FA00002

First Aid Kits

This water-resistant plastic container was engineered to fit securely and easily into your vehicle's trunk, protecting contents.

- Supplies to provide immediate care in medical or trauma emergencies
- Includes personal protection kit to prevent contamination from blood or body fluids
- Case has removeable tray and locking latch
- Separate flip-top lid has storage for small items
- 10-1/4"H x 15-1/2"W x 8"D
- Made in USA



FA00003

Dyna Med® Rescue Responder Kit

Includes essential first aid supplies for first responders as well as supplies to protect against biohazards. Compact design fits easily in your vehicle's trunk.



FA00004

Dyna Med® Vehicle First Aid Kit

Contains all the supplies you need to administer basic first aid.

- Compact design stores easily in your vehicle
- Hard plastic case
- 4-1/2"H x 7-3/4"W x 1-1/2"D



Dyna Med® 50 Person First Aid Kit

- Meets ANSI Z308.1 - 1998 standard
- Sturdy metal case
- 2-3/4"H x 13-1/2"W x 9-1/2"D



Dyna Med® Personal First Aid Kit

Stocked with basic supplies in an easy to store package.

- Compact zip-lock nylon bag
- 5-1/2"H x 6-1/2"W x 3-3/4"D

sellstrom Personal Eye Washes



FA00007

AOSafety First Aid Kit for 50 persons



FA00008

AOSafety First Aid Kit for 25 persons



FA00009

Travel Kit by AOSafety

Roadside Auto Emergency Tool Kit



FA00010



FA00014



FA00015



FA00016

The Brookstone Auto Emergency Tool Kit is a comprehensive kit that includes everything you will need for a wide variety of roadside emergencies.

The auto emergency tool kit includes:

- Heavy-duty plug-in air compressor
- Digital tire gauge to quickly tell air pressure
- 28-piece first aid kit
- Emergency light
- Jumper cables
- Reflector triangle
- Lug wrench and double-sided sockets
- Flat head and Phillips screwdrivers
- Insulated slip-pliers
- Durable snap-close organizer case



FA00011



FA00012



FA00013

Dyna Med® Maxi-Medic® Bag with Waterproof Bottom

This medium-sized bag provides plenty of room for Basic Life Support (BLS) Equipment for management of airways, burns, and skin traumas in addition to standard supplies. With it's waterproof bottom you can set this bag virtually anywhere - snow, puddles or mud - and be confident that your equipment will be dry when you need it.



FA00018



FA00019

Dyna Med® Vehicle First Aid Kit w/ Nylon Pouch

Contains all the supplies you need to administer basic first aid.

Compact design stores easily in your vehicle
Nylon pouch
5"H x 8-1/2"W x 2"D



FA00017

Protective Clothing



PC00102



PC00100



PC00101



PC00105



PC00103



PC00104



PC00106



PC00107



PC00108

APRON - SLEEVE - LEG GUARD



PC00111



PC00112



Split Leather Apron

PC00113



Split Leather Arm Protector

PC00114



Split Leather leg Protector

PC00115

Body protection

Protection against Heat, Acid and Antistatic



BP00511



BP00516



BP00513



BP00515



BP00512



BP00514



BP00517



BP00520

Workwear



BP00521



BP00522



BP00523



BP00524



BP00525



BP00518



BP00526



BP00527

Protection against chemics



PC00700



PC00701



PC00702



pC00704



PC00703



DS00700



DS00701



DS00703



DS00704



DS00705



DS00702



DS00706



DS00707



DS00708

Disposables

Body Protection - Welding



BP00611

Cowhide apron, dimensions: 90cm x 60cm, leather straps with plastic bucklet.



BP00612

Cowhide apron with bib. Link with belt buckle. Dimension: 90cm x 70cm.



Cowhide welder's jacket. Made-up long sleeves. Velcroed fastening under flap. Straight cuffs. Mandarin collar. 73 cm



BP00613

Cowhide welder trousers, side pockets, elastic waist, fly with press snap fastener. Kevlar® sewn.



BP00614



BP00618

Hood of welder in fabric cotton PROBAN® 320 gr /m², tightened cord around the face, flap covering the shoulders. Aramid sewn.



BP00619



BP00620



This standard is applicable to protective clothing for the workers of industry exposed to heat.

Standard EN470-1 specifies the testing methods and the general requirements of performances of protective clothing intended for the operators of welding and related techniques presenting of the comparable risks.

This type of protective clothing has as an aim to protect that which carries it against small metal projections in fusion, the contact of short duration with a flame, like against the ultraviolet radiations.



BP00615



PC00116

Hi Visibility Jackets and Vests

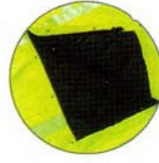

PC00126



PC00120



PC00121



PC00122

High visibility padded thermal jackets



PC00121



PC00123



PC00124



High visibility Jackets and Vests
High visibility winter and road side jackets.
High visibility foul weather Jacket
Insulated Jackets and reflective harnesses.

Hi Visibility Jackets



HV00700



HV00701



HV00702

HV00703



HV00704



HV00705



HV00706

and Vests



HV00707



HV00708

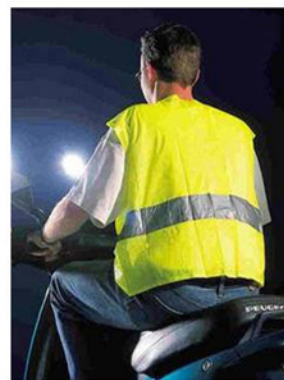

HV00711

HV00712



HV00709



HV00710

Head Protection



AO Tuffmaster Facesheild/Headgear System



IPSS Can provide different sorts of hardhats

- Standard MSA hardhats
- Standard hardhats with ties
- Welding hardhats
- Welding hardhats with ties
- Fire hardhats
- Fire hardhats with ties



Head Protection





Face Protection

Disposable Masks

PROVEN Pleats Plus N95 and R95 Folding Style Particulate Respirators



FP00300



FP00301

Made in USA



FP00302



FP00303



FP00305

MSA



FP00312



FP00304

3M



FP00313

3M™ 8246 R95



FP00306

3M™ 8247 R95



FP00307

3M™ 8511 N95



FP00308



FP00314

3M™ 8210 N95



FP00309

3M™ 8212 N95



FP00310

3M™ 8233 N100



FP00311



FP00315

Eye and Face Protection

IPSS



NEW QuickFit™ Full Face Air Purifying/Air Supplying Respirators* With Easy On-And-Off Knob



OMNI STAR
(Medium)
FP00312



AO 7 STAR with *posi-test™* push button feature for quick positive pressure fit check. (Small/Medium and Medium/Large)
FP00313



FP00314

Made in USA



FULL FACE MASKS



FP00315



FP00316



FP00317

Made in Germany

Full Face Mask

MSA 3S-Basic Full Face Masks
(with C E marking)

The MSA 3S-Basic FullFace Masks (except 3S-R) are used for 2-way breathing in combination with filters, compressed air breathing apparatus fresh air hose and compressed air line breathing apparatus. 3S stands for 3 terms: Safety, Sight and Styling describing the advantageous features. All rubber parts made of skin compatible rubber compound silicone. Pressure-free fit due to wide; Sealing edge and deep chin stop; single size; Quick donning & removal; No lens fogging due to special air flow; Low inhalation and exhalation resistance; Large field of vision to all directions; and Low weight



FP00320

HALF FACE MASKS



FP00321

Eye and Face Protection

IPSS

HALF FACE MASKS



QuickLatch™

New QuickLatch NIOSH Approved Air Purifying Half Mask Respirators
The only respirators with the easy on - and - off latching system

Studies show workers remove and refit respirators up to 20 times a day. These frequent on-and-offs waste lots of time fumbling with straps, buckles and other equipment. Now, there's a better way.

Just flip the latch and the respirator slides off the face.

QuickLatch respirators require no clumsy tugging or strap stretching. Wearers don't have to remove hardhats, welding helmets or safety glasses, either. Instead, QuickLatch respirators save workers time. And saving time increases their productivity.

Refitting is just as simple.

Just close the latch and the respirator slides back into place on the face. It's simple enough to do with one hand.

Plus,

QuickLatch respirators have more advantages including:

- Contoured flange for exceptional fit and comfort
- No-snap straps with comfortable curved neck buckle
- Available in three sizes
- Choice of reusable (silicone or natural rubber) or low maintenance (TPR man made rubber)
- Replacement parts available for reusable models
- Users bayonet style filters or plastic cartridges
- Fit testing accessories available



FP00318

(Price is exclusive of cartridge filter)

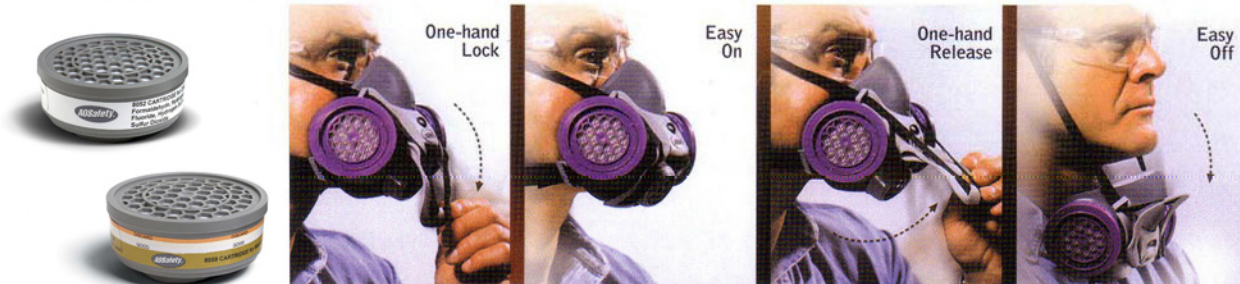

Unistar™ Quarter Mask Respirator

Reliability, Fit, Comfort and Versatility

This lightweight rugged quarter mask, which has stood the test of time in industry, combines reliability, comfort and versatility. Available with an N95 or P100 filter, UNISTAR is NIOSH approved.

Features and advantages include:

- Comfortable, soft rubber or silicone facepiece
- Uses a single filter (N9510 or R57B-P100) which means cost savings when compared to dual-filter half mask respirators
- Small profile doesn't interfere with eyewear and results in less material in contact with face for more comfort in hot and humid environments
- Double exhalation valves for easy breathing
- Adjustable rubber headband w/2 point suspension to allow for "carrying around the neck" when not in use
- Compact size allows wide field of vision
- Disassembles easily for cleaning and part changes
- Probed version or fit test adapter available for quantitative fit-testing

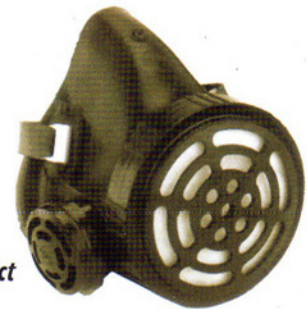

FP00319

Made in USA



Eye and Face Protection

IPSS

High Quality Safety Glasses



DX™ anti-fog, super-tough lens coating.



Seepro Plus™ offers adjustable temples for a custom fit.



Seepro Plus™ offers adjustable temples for a custom fit.



DX™ anti-fog, super-tough lens coating



Seepro Plus shown.



All lenses absorb 99.9% harmful UV Radiation.

All Lenses absorb 99.9% harmful UV Radiation.

Black/Clear



Black/Gray



Blue/Gray



Blue/Gray



Red/Gray



Red/Gray



Black/Amber



Black/Amber

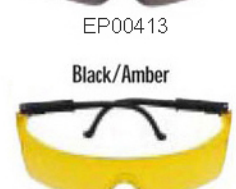

EP00417

Frame Color: Platinum
Lens Color: Blue Mirror
90988-00000
0 78371 90988 8
6 count replacement shipper



Frame Color: Steel Blue
Lens Color: Yellow Mirror
90989-00001
0 78371 90989 5
6 count replacement shipper





EP00420

Visitor Glasses That Are A Great Look And Great Value

Many visitor glasses are "boxy" looking. Not KX eyewear. It's stylishly contoured to wrap around the face for a sporty look and excellent safety coverage. And they are economically priced.



EP00421



EP00422

Choose from clear or gray lens.



EP00423



Patented, Easy Change™ lens system allows lens change-out in seconds.



EP00427



EP00428



DX™ Anti-Fog Hard Coat.

Meets ANSI Z87.1 standards

Tough, polycarbonate construction resists impact and 99.9% of UV rays



EP00423

Contoured, flexible temples for snug and comfortable fit

Universal nosebridge fits most people and helps prevent slippage

Very lightweight design - less than 1 ounce

Sleek, 9.5 base lens wraps for superior protection and unobstructed view

A1655  ISO9001
Acero Company
Southbridge Operations

Three Versatile Lens Choices



Clear

EP00424



Gray

EP00425



Indoor/Outdoor

EP00426

BIG FOOT

SAFETY SHOE



FP00500

OIL RESISTANT	ANTISTATIC	STEEL TOE 200J	WATER RESISTANT UPPER	SLIP RESISTANT	COLD/HEAT INSULATION	ABRASION RESISTANT
ANTI PUNCTURE PERFORATION RESISTANT	METATARSAL PROTECTION	ANTI BACTERIAL BREATHABLE INSOLE	HYDRO CARBON RESISTANT	SHOCK ABSORBER	HEAT RESISTANCE 200°	GRAIN LEATHER



FP00501



FP00502

OIL RESISTANT	ANTISTATIC	STEEL TOE 200J	WATER RESISTANT UPPER	SLIP RESISTANT	COLD/HEAT INSULATION	ABRASION RESISTANT
ANTI PUNCTURE PERFORATION RESISTANT	METATARSAL PROTECTION	HYDRO CARBON RESISTANT	SHOCK ABSORBER	HEAT RESISTANCE 150°	SPLIT LEATHER 1.8MM	



FP00503

Foot Protection

IPSS

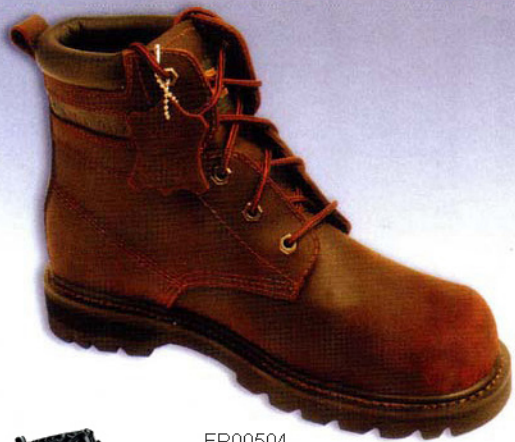

FP00504



FP00506



FP00509



FP00511



FP00513



FP00510



FP00512



FP00514



FP00508



FP00507



OIL
RESISTANT

ANTISTATIC
14KV

STEEL TOE
200J

WATER
RESISTANT
UPPER

SLIP
RESISTANT

COLD/HEAT
INSULATION

ABRASION
RESISTANT



ANTI
PUNCTURE
PERFORATION
RESISTANT

METATARSAL
PROTECTION

HYDRO
CARBON
RESISTANT

SHOCK
ABSORBER

HEAT
RESISTANCE
350°

SUEDE
LEATHER



FP00515



FP00517



FP00516

Steel Toe Safety Footwear



FP00510

Oil resistant
Antistatic
Water resistant
Anti Puncture
Shock Absorber



FP00511

Antistatic
Water resistant
Anti Puncture
Shock Absorber



FP00512

Oil resistant
Antistatic
Water resistant
Anti Puncture
Shock Absorber



FP00513

Oil resistant
Antistatic
Waterresistant
Anti Puncture
Shock Absorber
Slip Resistant

Rubber Footwear



FP00514



FP00515



FP00516



FP00517



FP00518



FP00519



FP00520



FP00521



FP00522



FP00523



FP00524

Fall Protection Belts

LINE MAN SAFETY BELT



FP00600

Model FC - 11

- (for U-shaped suspension only)
- Vinylon life line
- Dia. 16mm, length 2,000 mm
- Nylon inner belt
- Width 75mm, length 650 mm
- Nylon outer belt
- Width 45mm, length 1,200 mm
- Weight approx. 1,660 g

Made in Japan

LINE MAN SAFETY BELT



ITEM	MEAST	QTY	N.W.	G.W.
H-227	2.9	10	22	23

FP00601

No: H - 227

Specification:

BELT: 50mm NYLON BELT

ROPE: 14mm x 2m NYLON ROPE

1 x DOUBLE-LOCK BUCKLE

1 x "D" RING

1 x TETRAGONAL RING

1 x SLIDING HANDLE

1 x DOUBLE-LOCK SAFETY HOOK



Made in Taiwan



FP00602

KANTON - 100

- Soft back pad for better support and comfort
- Two side D-Ring attachments
- 45mm nylon web
- 1.5 meter Rope Lanyard + double snap hook
- Additional hooks for hanging the tool

Made in Taiwan



FP00603

KANTON - 50

- Nylon belt (waist belt): length 1.200mm width 50mm Thickness 2.1mm green, B.S. over 2000kgs.
- Nylon Rope: length 1.600mm DIA 13mm ø B.S. over 900kg
- Hook, Buckle: flat double snap hook, slide type buckle
- "D" Ring: fasten with nylon ring stopper
- Net weight: 640g

Made in Taiwan



FP00604



FP00605



Sala
Fall Protection
and Rescue Systems
Full Body Protection



FP00606



FP00607

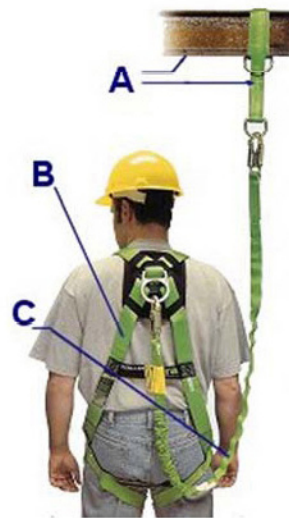

FP00608



FP00609



FP00610



FP00611



FP00612



FP00613

Call Point Safety Signs



ფრთხილად
დაბალი ტემპერატურა
Danger
Low temperature
Осторожно
Низкая температура

SS00700



ფრთხილად
ელექტრობა
Danger
Electrical
Осторожно
Электричество

SS00701



SS00702

დავრეულ ზღვრის მიღმა
შესვლა აკრძალულია
No unauthorised personnel
allowed beyond this point
Посторонним вход
запрещен за
ограничительную черту

საშიში ნარჩენები
Hazardous waste
Опасные отходы

SS00703

ფრთხილად,
მოძიებზე მოძრაობა
Caution
Site traffic
Осторожно,
движение на объекте

SS00709

ფრთხილად
ცეცხლია
Fire action
Осторожно
огонь

SS00710



SS00704

ცეცხლსაქრომი
Fire extinguisher
Огнетушитель

SS00711



მუკავის დაცვა აუცილებელია ამ
ტერიტორიაზე
**Ear protection must be
worn in this area**
Защита ушей необходима
на этой территории

SS00705



დაცვადი ნიღაბი აუცილებელია
Wear face shield
Необходима защитная маска

SS00706



თვალის დაცვა აუცილებელია ამ
ტერიტორიაზე
**Eye protection must be worn
beyond this point**
Средство защиты глаз необходимо
на этой территории

SS00707



უსაფრთხო ფეხსაცმელი
აუცილებელია
**Protective footwear
must be worn**
Защитная обувь
необходима

SS00708

Face-Adhesive Safety Signs

- Disability Awareness
- Pedestrian and Traffic Control
- Hazardous Substance Control
- Pipeline Marking
- Site Maintenance
- Risk Assessment and Safety trainings
- Electrical Safety



**No
thoroughfare**

SS00712



Danger
Slippery surface

SS00713

Warning Tapes



SS00714

Hazard Warning Tapes
Bioactive Material



SS00716



SS00717



SS00718



Warning tapes with Diagonal warning
stripes for additional visual impact.



SS00715

SOFTEN & SHAPE WITH BODY HEAT.



Available with
or without cord



Thermal-Reactive Foam™ Gets
More Comfortable With Wear.



EP00800

Smoother plug surface.



EP00801

E•A•R Classic



EP00802

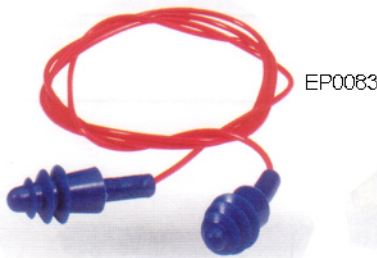

EP00803



EP00804

World's Most Popular Earplug!

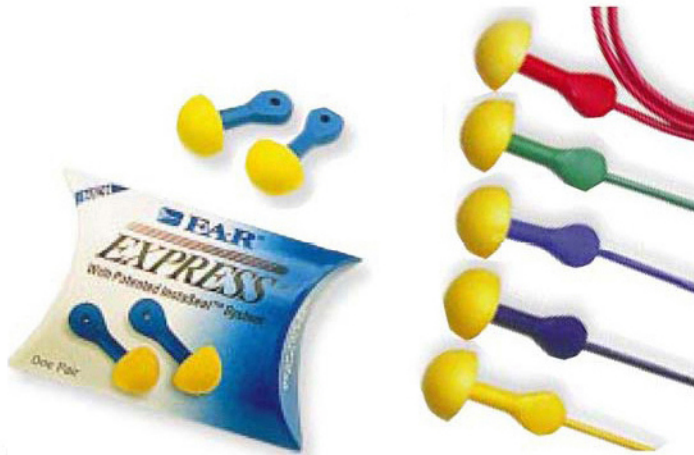

EP00803

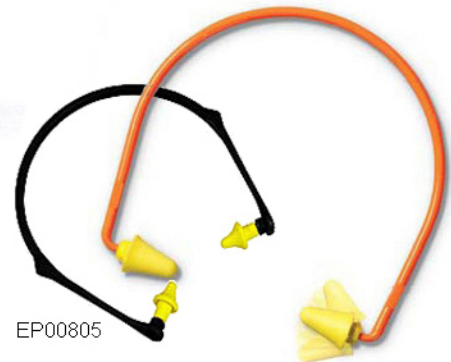

EP00805

EP00804

E•A•Rflex 28™
Semi-aural Hearing Protector
another leading advancement
in hearing protection.



EP00801



EP00802

New Headset range

With its carefully designed microphone/speaker system and excellent attenuation, the new headset range offers unique acoustic performance providing outstanding communication in very high noise environments. Peltor's proven and durable designs ensure high comfort levels, allowing long term use under very tough conditions.



Individually sprung headband wires of stainless sprung steel provide an even and consistent distribution of pressure around the ears.

EP00805

Soft, wide foam and fluid-filled sealing rings with built-in pressure-equalizing channels provide low pressure, effective sealing and ideal comfort.

High attenuating cups with optimised acoustic design and excellent space for the ears for best possible sound quality and comfort.

Beam-mounted earphones that provide the least possible resonance and distortion for excellent sound reproduction even in very high noise environments.

Low, two-point fasteners and easy height adjustment with no protruding parts.

Mike arm Quick and easy to set distance, length, height, angle. Easy to switch between speech and standby mode.

Microphone with excellent suppression of ambient noise for clear and reliable communication.

Connection cord, insulated with flexible polyurethane and with a moulded connector.



EP00806

Headband (A) Extra broad with soft padding for ideal comfort throughout the working day.



EP00807

Foldable headband (F) For convenient storage when you are not using the headset



EP00808

Neckband (B) For situations where the headband must not be in the way.



EP00809

Helmet attachment (P3E) Allows the headset to be attached on most of the common helmets.

Attenuation tables

The headsets are tested and approved according to PPE directive 89/686/EEC and applicable parts of the European EN 352-1:1993 standard. Attenuation values from the test report for certificate issued by the Department of Physics, Finnish Institute of Occupational Health, Topeliuksenkatu 41, FI-00250 Helsinki, Finland, ID# 0403. Explanation of the attenuation value table: 1) Frequency in Hz. 2) Average attenuation in dB. 3) Standard deviation in dB. 4) Average Protection Value.

Headband, foldable headband and neckband (A, F, B)

Model	Frequency ²	125	250	500	1000	2000	4000	8000	H	M	L	SNR
**	Mean att. ³	17.7	27.1	33.8	38.1	36.2	33.6	37.1				
	Stand. dev. ⁴	2.9	2.1	2.4	2.6	2.3	2.5	2.2	33 dB	32 dB	24 dB	33 dB
	APV	14.8	25.0	31.4	35.5	33.9	31.1	34.9				

Helmet attachment (P3E)

Model	Frequency ²	125	250	500	1000	2000	4000	8000	H	M	L	SNR
**	Mean att. ³	17.2	26.4	33.9	37.2	35.4	33.2	37.0				
	Stand. dev. ⁴	3.1	2.5	2.7	2.3	2.6	2.4	2.0	33 dB	31 dB	23 dB	32 dB
	APV	14.1	23.9	31.2	34.9	32.8	30.8	35.0				

The new ONE TOUCH™ earplug dispenser

Now with one gentle turn users get the most popular hearing protection in the world.

Choose from the widest variety of earplugs available in any earplug dispenser today.

E-A-R ONE TOUCH offers the popular E-A-R Classic® the new E-A-R Classic SuperFit and EARsoft™ Yellow Neons™ earplugs.

Both E-A-R Classic SuperFit and EARsoft feature the highest NRR available - 33dB.

ONE TOUCH Product Line



EP00810

ONE TOUCH Base 391-1000



EP00811

E-A-R Classic 391-1001
NRR 29 - 500 pairs per bottle



EP00812

Superfit 30™ 391-1002
NRR 30 - 500 pairs per bottle



EP00813

E-A-Rsoft Regular 391-1004
NRR 33 - 500 pairs per bottle

Superfit 33™ 391-1003
NRR 33 - 400 pairs per bottle

E-A-Rsoft Large 391-1005
NRR 33 - 400 pairs per bottle

- The E-A-R ONE TOUCH offers the widest line of earplugs of any dispenser, including 3 earplugs with the highest NRR available - 33dB, all tested in a NVLAP accredited lab.
- The new ONE TOUCH features the most reliable delivery system in the world.
- The patented "No Waste Funnel" system allows users to reuse both the base and dispensing unit.
- For a free ONE TOUCH dispenser base call 1-800-204-1504 or visit us on the Web at www.EARdispenser.com.



LEADING THE ADVANCEMENT OF HEARING PROTECTION.

TECHNICAL INFORMATION

Phone: 1-800-444-4774
Fax: 1-508-764-5640
www.e-a-r.com

U.S. CUSTOMER SERVICE

Toll Free: 1-800-225-9038
Fax: 1-800-488-8007

OUTSIDE OF NORTH AMERICA

Phone: 1-317-692-6666
Fax: 1-317-656-5760
E-mail: customer_service@aearo.com

E-A-R

8001 Woodland Drive
Indianapolis, IN 46278
United States of America

E-A-R® Classic®, E-A-Rsoft™ Yellow Neons™, SuperFit 30™, SuperFit 33™, and ONE TOUCH™ are trademarks licensed to Aearo Company
©2000 Aearo Company Lit Code #33126

Hand Protection



HP00900



HP00901



HP00902



HP00903



HP00904

C - SHIELD PLUS 500 SERIES

- PVC DOUBLE DIPPED GLOVE
- ROUGH SANDY FINISH
- INTERLOCK OR JERSEY LINED

NORTH GRIP N KEVLAR HEAVY HOT MILL

Seamless Knitted, Kevlar plated, double ply, with brown "N" coating on both sides. Heat protection up to 250 degrees Celcius.



CHAINEX GLOVES



Welded stainless steel links

HP00905



HP00906



HP00907



HP00908



HP00909



HP00910



HP00911

Hand Protection



HP00912



HP00913



HP00914



HP00915



HP00916



HP00917



HP00918



HP00919



HP00920



HP00921



HP00922



HP00923

Ansell



HP00928

Oil-Tuf Complex Design

- A ground-breaking new glove specifically developed for the toughest, oiliest conditions.
- The best oil grip ever provided by any synthetic glove.
- Outstanding mechanical resistance.
- PLUS thermal protection for intermittent contact upto 350°C in accordance with EN407.



HP00933

Saturn Terrycloth Intermediate Design

- Terry loop protection against mechanical handling hazards.
- No seams where dangerous sparks may lodge.



PREMIUM
DOUBLE-DIPPED
PVC

This Premium Double-Dipped PVC green glove has a jersey lining and is treated with ACTIFRESH®. Industry applications for the green colored glove include oils and solvents, petrochemicals and refining. This glove is manufactured with a special blend of high quality plasticizers and resins for maximum flexibility and chemical protection.



HP00936

Electro



the absolutely safe KCL protective gloves made of special natural latex. Test stamps for work with voltages of up to 500V, 1,000V, 7,500V, 17,000V and 26,500 volts. Anatomical design and very good flexibility provide good sensitivity. Different wall thicknesses of the gloves are designed to meet specific requirements. In the classes 0 and 00 we also offer the gloves with cotton flick lining.

Application:

- Power supply and installation companies
- Electrical workshops in all branches of the industry
- Installation, maintenance and repair work involving high voltages



HP00929



HP00930



HP00932



HP00931



HP00934

DISPOSABLE
LATEX



HP00935

ECONOMY SINGLE-DIPPED PVC

This economy single-dipped PVC glove has an interlock lining with either a smooth or rough finish. Additional uses include utilities, petrochemicals, fishing, ship building, handling abrasive materials coated with grease and oil, caustics, acids and solvents. Provides liquid and basic chemical protection for refining, mining and utilities, petrochemicals, fishing, ship building, handling abrasive materials coated with grease and oil, caustics, acids and solvents.



HP00937

Hand Protection

IPSS



WJ01100

Free Thinker Jacket

Premier jacket for all mountain needs



WJ01101

Sedition II Stretch Jacket



WJ01102

Stitchless Insulated Universal Jacket



WJ01103

Stitchless Fountainhead
A Fully welded,
seam-sealed jacket



WJ01104

Caber Hybrid Jacket
Technically advanced fabrics



WJ01105

S.T.H. Jacket
Apex™ Weatherblock
technology



WJ01106

Vortex Triclimate Jacket
Waterproof, breathable, fully seam sealed



WJ01107



WJ01108

Cryostat Triclimate Jacket
Offers three-in-one versatility for varying weather conditions.



WJ01109

Pure Mountain Jackets

Materials:

Body: TD 10 000

Shoulders: PJ 10 000

Insulation: Comfort (B: 100 g - S: 80 g)

Main seams sealed

DWR water-repellent finish

Technical features:

See all the details of R. CONCEPTION

+ Diagonal ventilation zips

Hybrid snow gaiters

Storm insulating removable hood

Thermofleece collar with chin protection

Articulated sleeves with Stop Lycra® cuffs

Cuff with embossed straps

Large internal mesh pockets to store goggles or gloves

Colors: Red, Leaf, Electric, Liquid Solar, Azur, Snow

Sizes: S-M-L-XL-XXL



ROSSIGNOL
PURE MOUNTAIN COMPANY®



WJ01120

Slammer Jacket



WJ01121

Meteor Jacket
Thermic Plus



WJ01122

Mandy Jacket
Water-repellent Finish



WJ01123

Lead Jacket
Thermal Plus



WJ01124

Accelerator Jacket
Thermic Comfort
Waterproof



WJ01125

Option Jacket
Thermic Plus



WJ01126

Ski Soft Jacket
Laminated Microfleece
Water-repellent coating



WJ01127



WJ01128



WJ01129



WJ01130



WJ01131



WJ01132

Winter Footwear



Water/Frost proof Shoes by Leading Brands



WG01200



WG01201



WG01209



WG01210



WG01211

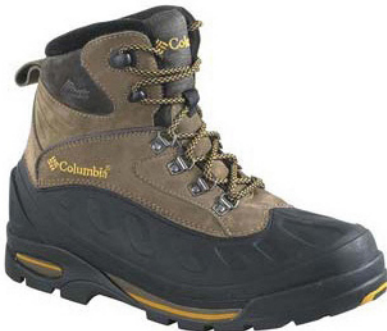

WG01202



WG01203



WG01204



WG01205



WG01206



WG01207



WG01208



Alaska Fire Protective Clothing for Firefighters



Made in USA



Head Protection



Fire and Rescue Safety



Respiratory Protection



Thermap Imaging



FPK01000

High Breathable Easy for water vapor to escape out. This feature is ensured by Evaporative resistance (Ret is lower than 7 m² Pa/W, the lower the better) and by MVTR (Moisture Vapor Transmitted Rate is higher than 600 gr./m²h, the higher the better).

High chemical resistance Total protection / no penetration when tested with acids, fuels, oil.



FPK01001



FPK01002

Smoke, heat and rate of rise detectors



FPK01003

Fire Resistant Boots



FPK01004

Fire extinguishers for home, office and outdoors

Water Based Fire Extinguishers
Powder Based Fire Extinguishers
Foam Based Fire Extinguishers
Carbon Dioxide Fire Extinguishers



FPK01005

FIRE BLANKET

Specification:

1.2 x 1.8m, 1.2 x 1.2m, 1.8 x 1.8m
(with silica gel cover or without silica gel cover)

Standard adopt:

QAS(QUALITY ASSURANCE SYSTEM) from Australia
EN1869-1997 Standard from British

Package:

PVC bag, PVC box/cylinder (Hard Case Packing)



HT01305

Infrared Thermometer



FPK01006

Body Protection for Firefighters



FF00900

Para-aramide Preox coat with aluminized Reflespace film 520 g/m². Entirely lined in Proban® flame-retardant cotton on the top part and the sleeves. DELTA design.



FF00901

Para-aramide Preox jacket with aluminized Reflespace film 520 g/m². Aluminized fabric stand-up collar. DELTA design.



FF00902

Para-aramide Preox trousers with aluminized Reflespace film 520 g/m². Standard belt. Adhesive band fly.



FF00903



FF00904



FF00905

Fire & Smoke Detection Systems



SS3A & SS3-AN

The Model SS3-A, (latching Fire Alarm relay), & SS3-AN (non-latching Fire Alarm relay), retains the outstanding capabilities of the Model SS2-A, but in a non explosion-proof, ABS housing. This Detector senses radiant energy in the Ultraviolet (UV), Visible and Wide Band Infrared™ (IR) spectrum. The radiant energy from all types of flaming fires will alert the detector to their presence. This low-profile detector has a mounting bracket that installs on a standard electrical junction box or to a flat surface, such as a wall or ceiling.

Model FS7 Fire Detection Systems for the Semiconductor Industry The Model FS7 Fire Detection System is a Electro-Optical radiant energy detector that sees Multi-Spectral Wide Band IR, Near Band IR and Visible Band energy from a fire. The Detector is used with the Fire Sentry Model FS7-130-SX controller or Model FS7-WB Control panel. The detector has been designed specifically for Clean Room applications and is used by major semiconductor and wet bench manufacturers worldwide.

FireSentry MultiSpectrum



FS 10

The fire detection and process control system provides a two-stage response for fires. ALERT detects "fireball" type fires in less than half a second in accordance with NFPA 33. If the fire continues to grow, a FIRE ALARM condition is declared in 4-5 seconds. Fire Detection systems are available with a Controller Card/Fire Detector combination or a Wallmount Controller/Fire Detector combination.



HPX - 751

NOTIFIER's HARSH™ (Hostile-Area Smoke Head) HPX-751 smoke detector provides early warning smoke detection in hostile environments where traditional smoke detectors are not practical.



Acclimate Plus

Acclimate provides an optimum balance of stability and early warning to maximise fire detection while rejecting unwanted nuisance alarms. Flash-Scan technology allows Acclimate to respond to a broad range of fires at a faster speed, grouping and scanning 10 devices at a time.



LPX - 751

The unique design of this detector, combined with enhanced AWACS™ algorithms in the NOTIFIER AFP-300/AFP-400 and AFC-600 control panels, allows smoke detection sensitivity that is 10 to 50 times higher than present photoelectric technology (clean environments).



RFX

Plans to add fire detection equipment to commercial buildings are often halted or run over budget because of wiring challenges created by ceiling or wall designs, some involving materials such as marble or rock. RFX wireless smoke detection system can be the solution.

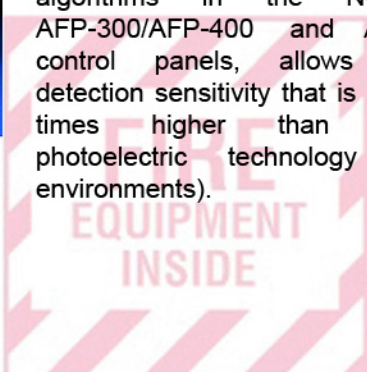

Pullman Holt Model 45 ASB Vacuum

Use to recover asbestos or lead. This compact and portable HEPA vacuum provides outstanding performance at an economical price. Equipped with a powerful 1.5 HP motor and an extra capacity HEPA filter system. Holds upto 10 gallons and has a waterlift of 87". Heavy-duty construction and materials make it a true work horse. Quiet design keeps noise level minimal. Meets NIOSH HEPA efficiency requirement.



45 ASB

Part Number	Description
FP00625	10 Gallon Dry HEPA Vac with Tool Kit
FP00626	Replacement Tool Kit
FP00627	Wet/Dry Conversion Adapter Kit
FP00628	HEPA filter
FP00629	Dacron Filter Bag
FP00630	Paper Filter - 1 ea



FP00631a



FP00631b



FP00631c

HEPA-AIRE Negative Air Machines

The H600V is lightweight and portable and ideally suited for use where space is limited. The compact design of the H1000V is well suited for smaller rooms where less airflow is needed, and a larger machine will not fit. Model: H1990HP can filter nearly 2,000 cfm of air yet weighs just 142 pounds. The most popular H2000HP model delivers the same superior airflow as the H2000HPA, but without the Magnehelic gauge and audio filter alarm. For large commercial projects, the powerful H5000C model is recommended. All machines feature solid-rivet construction, gasketed critical seams, carrying handles, recessed controls, 2-3 filtration stages, a HEPA filter and meet or exceed applicable U.S. and Canadian Safety Standards.

Dri-Eaz Dehumidifiers

A Dri-Eaz dehumidifier is the linchpin of your restorative drying system. Without a proper dehumidifier, air movers would continually circulate evaporated moisture and cause secondary damage, Dri-Eaz dehumidifiers are finely tuned restoration machines that remove water vapor from the air and surrounding structural materials and feature, a hot-gas bypass defrost, touchpad controls, an hour meter, centrifugal water pump-out with 40-foot hose, a high airflow, semi-pneumatic wheels, and are UL,C-UL listed for safety.

Part Number	Description
FP00632	DrizAir Evolution LGR
FP00633	DrizAir LGR 2000
FP00634	DrizAir 1200



FP00636



FP00637

Pullman-Holt F500 Blower Fan

The F800 Blower Fan is designed to provide quick and uniform drying. The 0.75 hp motor operates on three speeds, adjusting the volume of airflow up to a maximum of 3500 CFM to meet your drying needs. The off-set toromolded carrying handle distributes the 38 pounds evenly.

Part Number	Description
FP00635	F500 Blower Fan, 20H x 17W x 19 D

MSA Orion Multi-Gas Detector

The Orion Multi-Gas Detector is a reliable and easy-to-use portable instrument for detecting the presence of O₂, H₂S, CO and combustible gas. It will stand up to the roughest handling in the toughest environments. Includes a built-in sampling pump for OSHA confined space entry.

Feature Include:

- One-Button Calibration
- Large, Easy-to-read Display
- Long-Life Battery
- Durable Sensors
- Carbon-filled Nylon Case

Part Number	Description
FP00638	3-Gas LEL, CO, O ₂
FP00639	4-Gas LEL, CO, O ₂ , H ₂ S



IP / CCTV Monitoring



Axis 211

The AXIS 211 is an indoor/outdoor IP camera with good resolution. It can be used outdoors with enclosure and includes built-in motion detection.



GS4600

GS1600



VivoTek IP6112

Indoor/Outdoor Network Camera with Excellent Video and Synchronized Audio includes dual compression - MPEG-4 and M-JPEG selectable.



GS4000G

GS4600H



GS4000

GS1200G



IQ Camera Systems

Very high performance network attached cameras with digital zoom capability.

Provides higher resolution than the Axis2420. The models IQ300/600 also provide better low light sensitivity.

There are different models to choose from: featuring a choice of 1280x1024, 1600x1200 or 2048 x 1536 resolution. The new high speed 700 series provides up to 30 fps performance and low light level sensitivity.

Sony provides a wide range of IP cameras for every application. The latest cameras include dual compression options(MPEG-4 or M-JPEG), making these cameras perfect for every application. Select from fixed, dome, or PTZ cameras.



Sony Cameras



Panasonic

Panasonic provides a wide selection of hybrid cameras that have both analog and network connections. They also have a number of dome and PTZ cameras that provide very good performance.

IPSS is the prime supplier for IP based camera security systems in the region.

Offering all the benefits of standard CCTV, which we may also supply, our systems have the added advantages of running over standard network system, meaning only one set of cabling need be installed and the ability to view cameras remotely from anywhere in the world via a standard internet connection. Meaning one can watch over their office back home while sipping margaritas on a beach in the Caribbean!

Our security team can provide a full service from conception and identification of client needs, including intruder alarm and motion detector systems, through the cabling and install process all the way up to post install configurations and user training.

Alongside this we can provide complete fire detection and alarm system to compliment our security solutions, thus providing a complete one stop office security and fire detection package.



HT01301



HT01300



HT01302

IT Systems & Network Design Division



Here at IPSS we pride ourselves on the quality we provide and with the IT Systems and Design division it is no different.

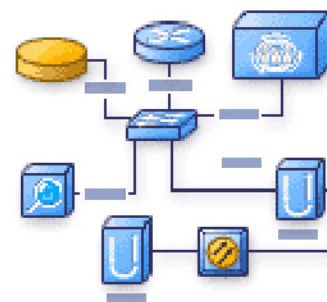

We can provide a cradle to grave service starting with the identification of your organization's requirements onto network and system design, full cabling and system installation on site and, where needed, bespoke configuration and training if necessary. All this coupled with clearly defined and agreed SLATs (Service level agreements) to provide post project system support to provide complete peace of mind.

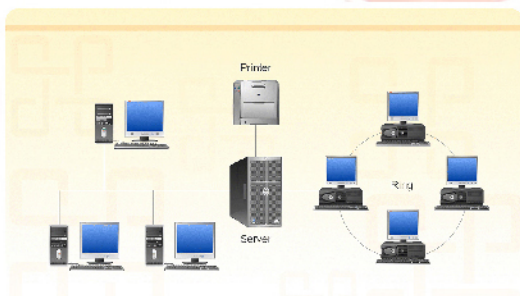

All of this is project managed from day one by members of our Design and implementation team who have over a quarter on a century of experience in all sectors of the industry from Private corporations to Government; local, national and international, NGOs in various countries, Banking and Healthcare.

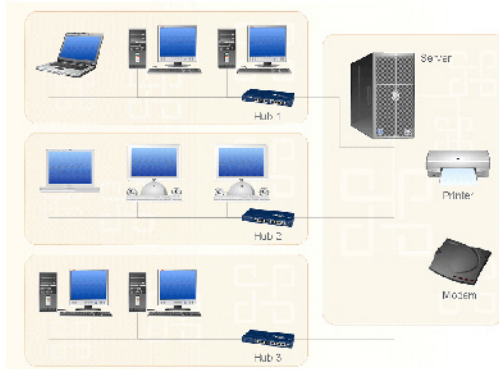

Only the best is deemed the right product for our clients and with that in mind all our networking equipment will be Cisco, 3Com or DLink. The same is true for hardware, peripherals and software; these are Dell, HP or Fujitsu Siemens, with Microsoft WindowsXP and Windows Server2003 being the software of choice.

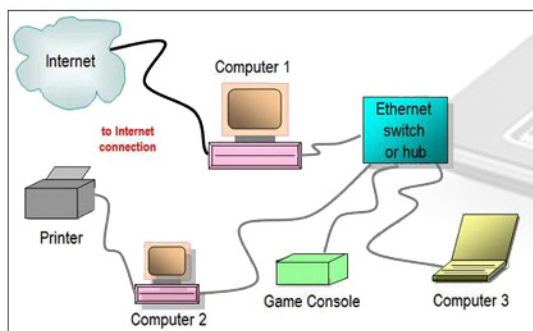

Pulling together this combination of the best hardware and components with some of the most experienced staff in the region allows IPSS to provide your organization with the most complete and ultimately cost effective business solution.

IPSS Safety Products And Construction Materials 2007-2008 Catalogue



**31, Makashvili st
Tbilisi, Georgia**

Tel: 921-670, 938-911
www.ipss.ge

IPSS Catalogue
2007-2008